



VERTICAL BAND SAWS

**INSTRUCTION MANUAL AND PARTS LIST
MODEL 14-10**

DAKE/PARMA



WHEN ORDERING PARTS

GIVE COMPLETE SERIAL NUMBER OF MACHINE
 GIVE PART NUMBER AND NAME
 GIVE AMOUNT REQUIRED

MODEL: 14-10 _____

SERIAL NUMBER: _____

DATE PURCHASED: _____

DAKE Division of JSJ
724 Robbins Road
Grand Haven, MI 49417

Phone: 616-842-7110 800-937-3253
 Fax: 616-842-0859 800-846-3253
 E-mail: technicalservice@dakecorp.com
 Website: www.dakecorp.com

Table of Contents

Specifications Page 3

Features Page 3

Adjustments Page 4

Lubricating Page 4

Blade Selection Page 5

Parts List Pages 6-13

Specifications

Part Number	988050 / 988051
Blade Width	1/4-1/2 inches
Blade Length	120 inches
Blade Speed	70/140/270/540
Band Wheels	2
Band Wheel Size	14 inches
Horsepower	1 h.p.
Throat Size (band to column)	14 inches
Maximum work height	10 inches
Worktable Dimensions	15 x 16 inches
Worktable Tilt	5° left / 45° right
Worktable Height	42 1/2 inches
Machine Height	76 inches
Machine Floor Space	24 x 28 inches
Weight	500 pounds

Features

Designed for high performance at a low price

Blade changes are quick and easy.

4 speeds that are easily adjustable.

Adjustments

Blade Tension Handle (Item A) – Used to remove and install saw blade. Also used to set the correct blade tension – Be sure blade is tight.

Upper Blade Wheel Cant Adjustment (Items B&C) – If your saw should get out of adjustment and the blade runs off the wheel or runs back against the lip, loosen the two bottom bolts on the wheel slide. Turn the set screw in or out to make the blade run approximately 1/32" away from the lip on the back of the wheel. Tighten the two wheel slide bolts. IMPORTANT: If the blade is allowed to run against the lip on the wheel it will wear the lip off.

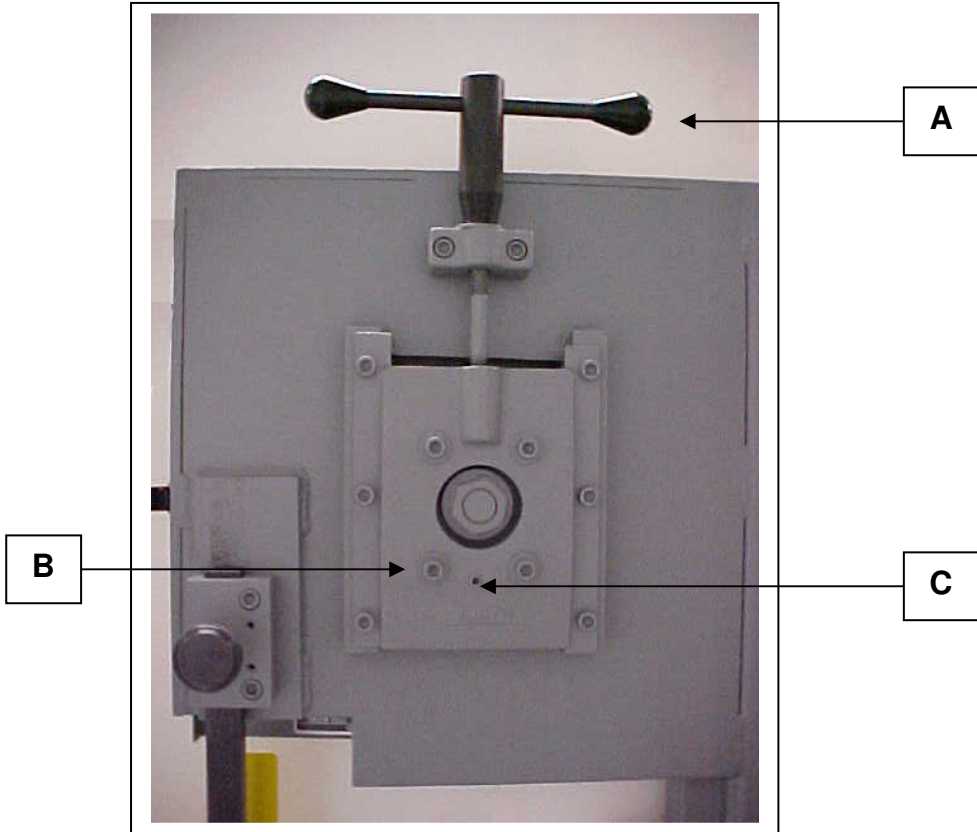

Lubricating

Gear Box: Your 14-10 gearbox is filled at the factory. Check the fluid level on arrival, and then check every six months thereafter. Use 90 weight gear lube to maintain fluid level at the fill / check pipe plug.

Blade Selection

For Operator convenience, a blade selector chart is located inside the saw cover. It provides recommended blade speeds, required teeth per inch, and minimum cutting radius for various blade widths. The following chart can be used to select the blade needed:

Standard Tooth Applications

Thickness of Material	Teeth per Inch
Up to 1/8"	18 Teeth
1/8" to 1/4"	14 Teeth
1/4" to 1/2"	10 Teeth
1/2" to 1"	8 Teeth
1" to 3"	6 –4 Teeth
3" to 6"	4-6 Teeth
6" and longer	3H

Note: 1) You must have at least 3 teeth into your work or blade damage will result.
 2) For straight cuts, a 3/4" inch blade is best.

Blade Speed (feet per minute)

To change blade speeds, lift the motor and move the v-belt to one of the three speeds offered: 70/140/270/540. Refer to the blade selector chart inside the cover on your 14-10 for the appropriate speed.

Blade Removal and Installation

To remove the blade, release the blade tension handle. (Item A on page 4). Remove the blade.

To install the blade, place the blade over the bottom wheel, then on the top wheel. Teeth must point down toward the table. Tighten the blade tension handle enough to hold the blade firmly in place, and then push the blade into the guide inserts. Turn the machine on to allow the blade to position itself and then finish tightening the blade. **IMPORTANT:** Blade must be tight to insure straight cut.

Please Note:

The most common causes for your 14-10 not cutting straight are:

- 1) Blade tension is too low.
- 2) The blade is either dull or worn on one side.
- 3) The blade is upside down. The teeth must point down toward the table.

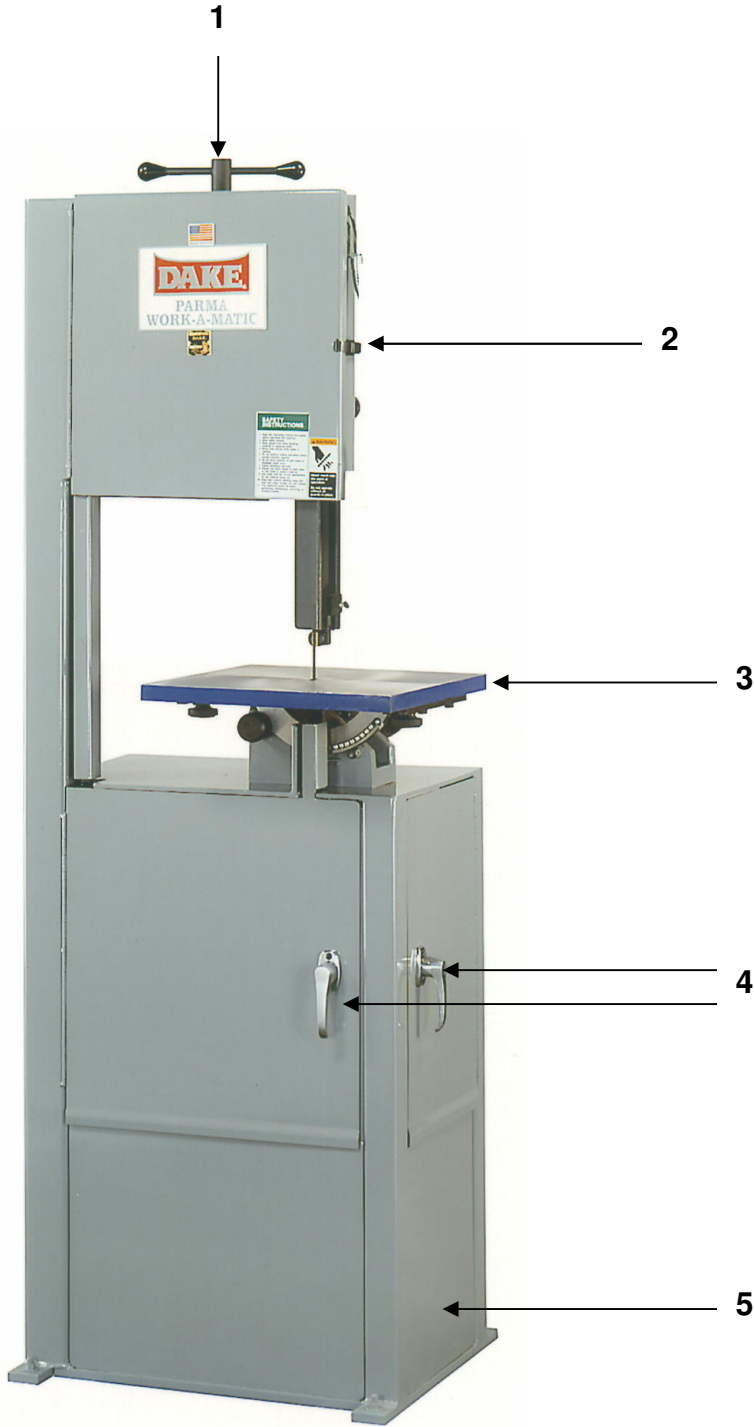

Item	Part Number	Description	Quantity
1	716716	Tension Handle Assembly	1
2	86747	Door Latch	1
3	87088	Table	1
4a	300568	Door Handle	2
4b	300569	Door Latch	2
5	716745	Frame Assembly	1

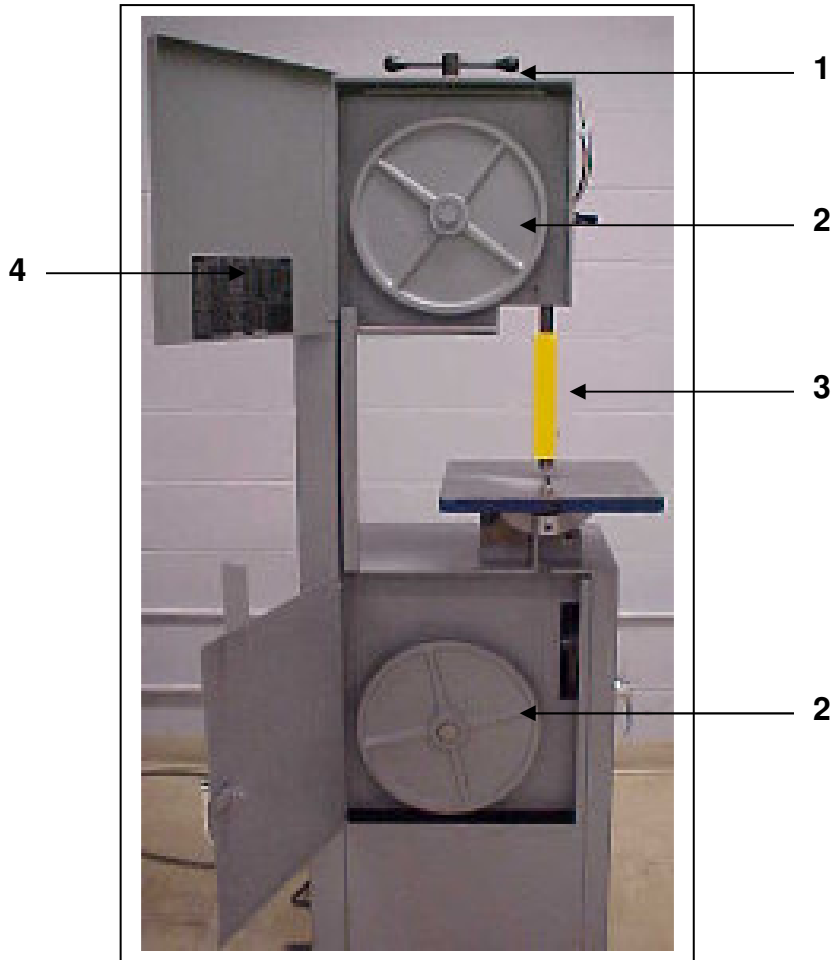

Item	Part Number	Description	Quantity
1	716716	Tension Handle Assembly	1
	86828	Tension Handle Body	1
	87104	Tension Handle	2
2	716705	Wheel Assembly	2
	300459	Band, Blade Wheel	1
	300466	Retaining Ring	2
	300693	Bearing, Wheel	2
	86795	Wheel Blade – Lower/Upper	1
	86803	Axle Wheel Lower/Upper	1
	86804	Stud – Wheel	1
3	300917 & 300918	Blade Guard	1
	300342	Thumb Screws	2
4	300585	Speed Selector Label	1

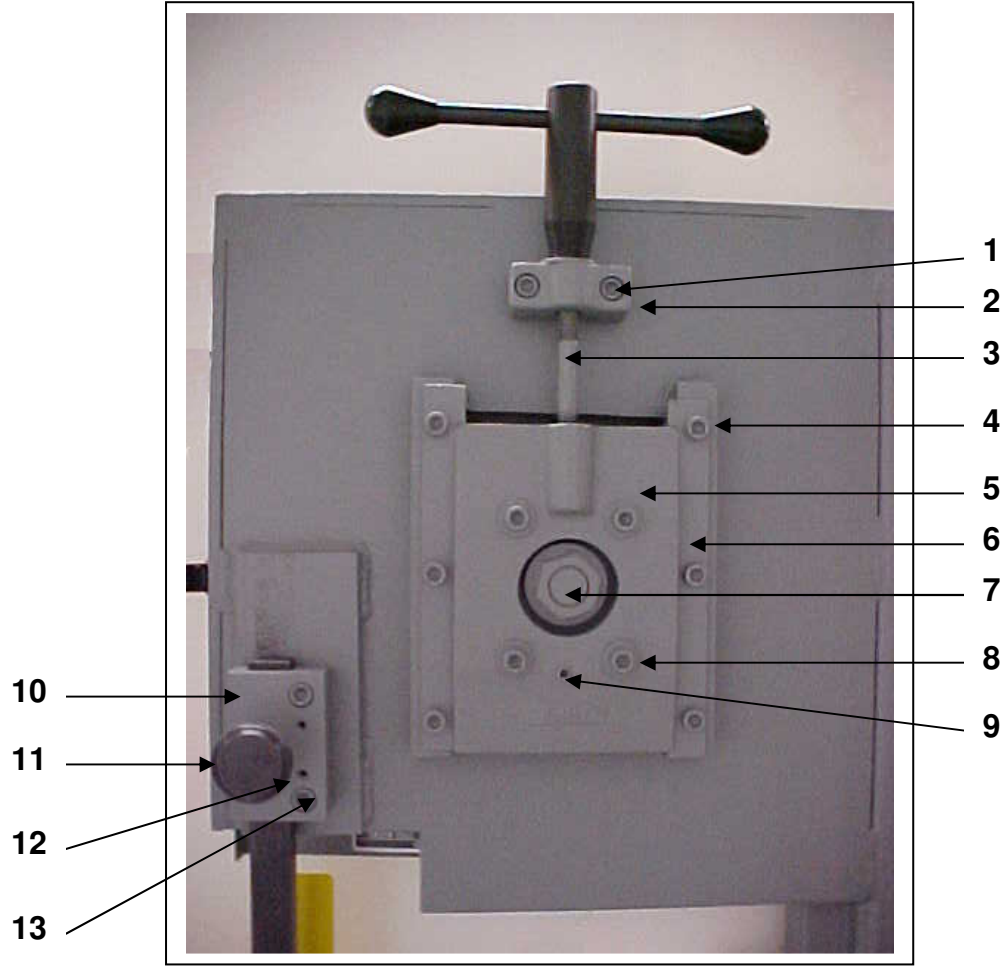

Item	Part Number	Description	Quantity
1	43450	Cap Screw	2
2	86827	Pillow Block	1
3	86830	Tension Screw	1
4	43447	Cap Screw	6
5a	86824	Wheel Slide – External piece	1
5b	86825	Wheel Slide Adjustment – Internal piece	1
6	86826	Rail Wheel Slide	2
7a	43922	Nut	1
7b	43638	Washer	1
8a	43452	Soc Cap Screw 3/8-16 x 1-3/4	4
8b	43632	Washer 5/16" flat	4
9	43591	Set Screw 3/8-16 x 1	1
10	86810	Guide Bar Holder	1
11	300832	Knob Assembly 1-1/2"	1
12	70287	Roll pin	2
13	43451	Cap Screw	2

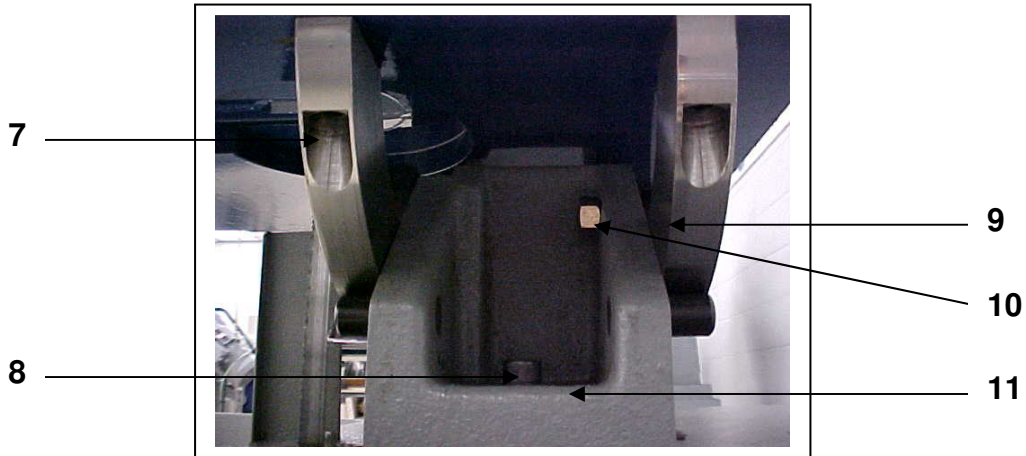
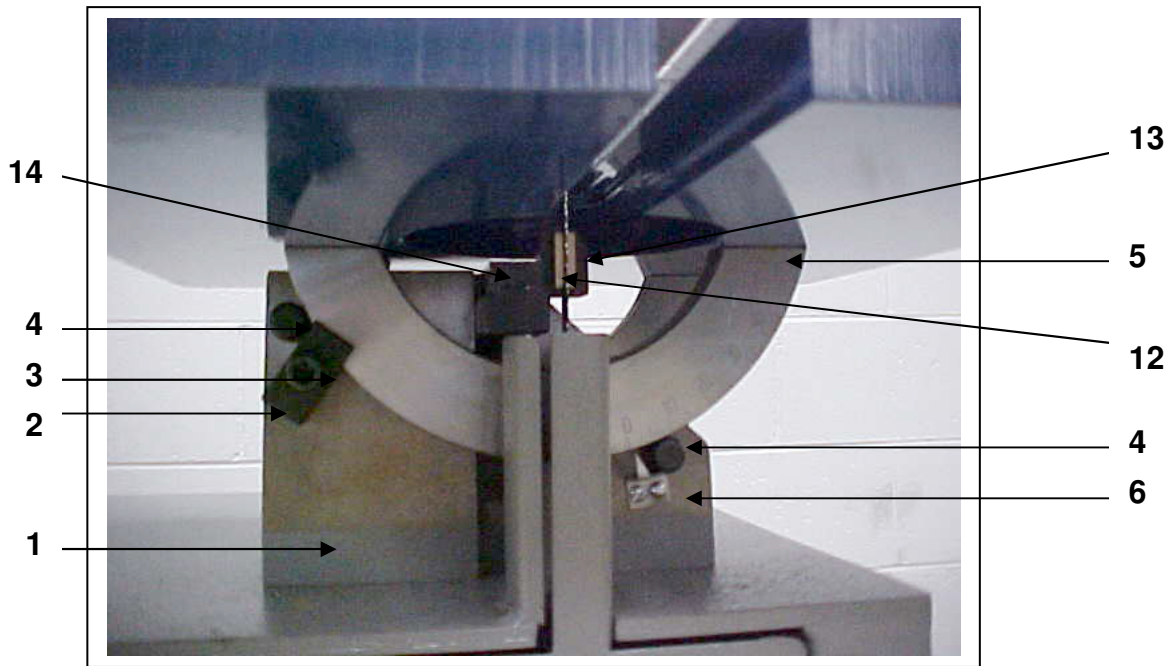

Item	Part Number	Description	Quantity
	716749	Saddle Assembly -	1
1	87081	Table Top Base	1
2	87025	Table Lock	1
3	43939	Nut, Hex Jam, 7/16-20	1
4	44033	Pin, Dowel	4
5	87078	Rocker Rings	2
6	87077	Pointer, Rocker Ring	1
7	43449	Screw, Soc Set	4
8	43451	Screw, Soc Cap	2
9	300564	Cam Follower	1
10	43939	Nut, Hex Jam 7/16-20	1
11	43591	Pin, Spiral or Roll	2
12	86806	Insert, Contour Guide Insert	1
13	87034	Lower Guide Holder 1 x 1-5/8" x 1-9/16"	1
14	87033	Guide Bracket 4" x 4" x 3/4" x 1" long	1

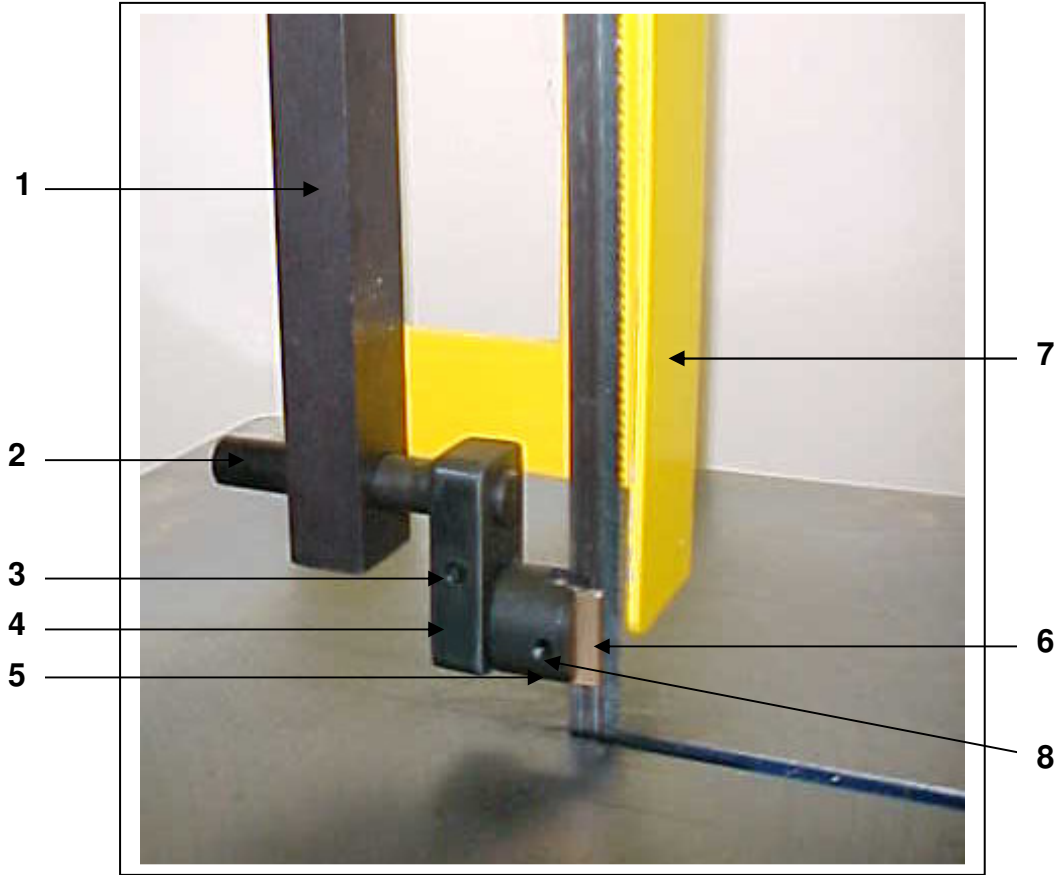

Item	Part Number	Description	Quantity
1	87029	Guide Bar	1
2	86912	Upper guide stem	1
3	43545	Screw, Soc Cap 1-1/2-6 x 4 1/2	1
4	87028	Upper Guide Swivel	1
5	86808	Holder Contour Insert	1
6	86807A	Insert Contour Guide 1/4" Blade Carbide	1
6	86807B	Insert Contour Guide 1/4" Blade Brass	1
6	86806B	Insert Contour Guide 1/2" Blade Brass	1
6	86806A	Insert Contour Guide 1/2" Blade Carbide	1
7	87012	Blade Guard	1
8	43545	Screw, Soc Set #10-24 x 1/4, Cup point	1

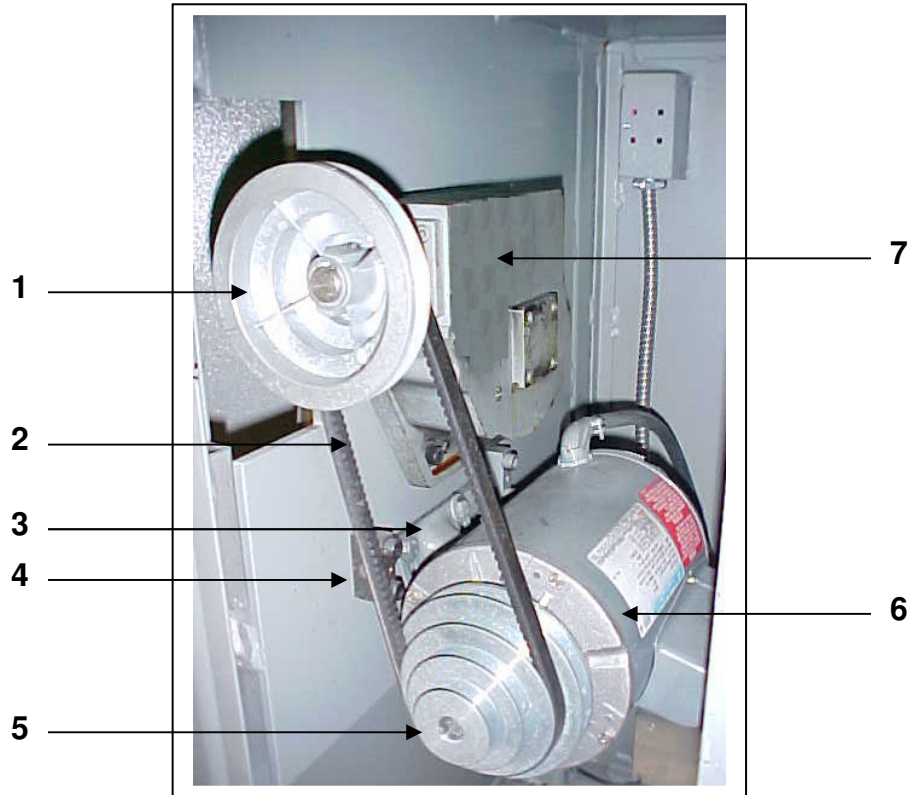

Item	Part Number	Description	Quantity
1	300473	Pulley, Gearbox	1
	77449	Key for Pulley	1
2	300522	V-Belt	1
3	86798	Motor mounting axle	1
	43314	Screw, Hex cap 5/16-18 x 3/4	2
	43632	Washer 5/16 inch flat	2
4	86800	Block, motor mounting	2
	43450	Screw, Soc Cap 3/8-16 x 1-1/4	4
	300597	Screw, Soc Set 1/4 – 20 x 1/4	2
5	300542	Pulley, Motor	1
	77449	Key for Pulley	1
6	300485	Motor, Single Phase	1
	300486	Motor, Three Phase	1

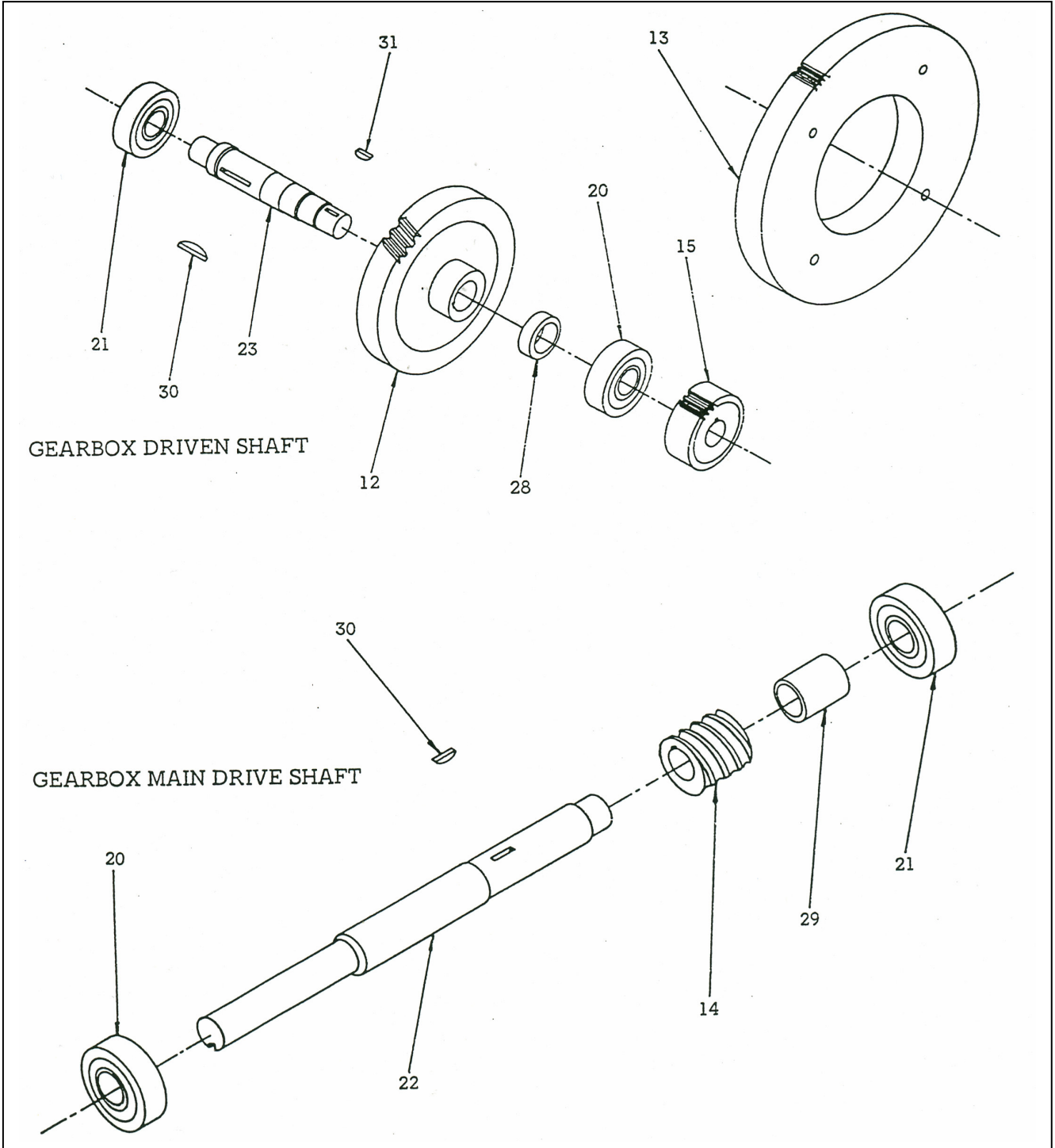

Item	Part Number	Description	Quantity
	716712	Gearbox Assembly	1
	300472	Bearing, Seal	2
	300490	Gasket, Gearbox	1
	300491	Gasket, Gearbox	4
	300589	Dowel Pin 3/16 x 1/2	2
	43412	Screw, Soc Cap	16
	43414	Screw, Soc Cap	6
	43590	Screw, Soc Set	3
	86820	Bearing Cover, Small/hole	2
	86821	Bearing Cover, Small	2
	86822	Gearbox Casting	1
	86823	Cover, Gearbox	1
12	300666	Gear, Worm 40T Bronze	1
13	86784	80 Tooth Gear	1
14	300456	Worm, 4-Lead	1
15	300646	24 Tooth Gear	1
20	300454	Bearing, Gearbox	2
21	300448	Bearing, Gearbox	2
22	86785	Shaft, Main Drive	1
23	86781	Axle, Gearbox-Short	1
28	86783	Spacer, Gearbox 1-1/4	1
29	86786	Spacer, Gearbox	1
30	300449	Key, Woodruff #13	2
31	300451	Key, Woodruff #5	1

Electrical components

Description	Part number
Contactora 460 volt	300715
contactora 230 volt 3 phase	300714
Contactora 220 volt 1 phase	300718
Contactora 110 volt	300717
Stop button	716539
Start button	716540
E-Stop button	716538

230 Volt Three Phase

460 Volt Three Phase